

CE

**Mantis**



# **Line Trimmer E System Débroussailleuse E-System E-System-Fadentrimmer**



**Owners manual and safety instructions  
Manuel d'utilisation et consignes de sécurité  
Benutzerhandbuch und Sicherheitshinweise**

© 2006 Mantis, Div. of Schiller-Pfeiffer Inc. All Rights Reserved.  
© 2006 Mantis, Division de Schiller Pfeiffer Inc. Tous droits réservés.  
© 2006 Mantis, Division von Schiller Pfeiffer Inc. Alle Rechte vorbehalten.

## Table of contents

### Important information

Introduction .....	1
Special safety information .....	1

### Safety and warnings

Safety labels .....	2
General safety rules .....	3

Assembly instructions .....	5
-----------------------------	---

Operation .....	6
-----------------	---

Maintenance .....	8
-------------------	---

Warranties policy .....	Back cover
-------------------------	------------

## Important information

### A. Introduction

This attachment is fitted with flexible string, intended to be used to cut weeds, grass, or similar soft vegetation.

### B. Specification

MODEL	SHAFT LENGTH	TOTAL WEIGHT
330104	62 cm	1.5 kg

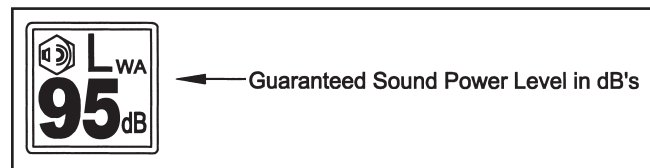

### C. Contents of the package

1. Line trimmer attachment assembly
2. Plastic guard with knife
3. Spool holder
4. Spool with flexible string

### D. Service information contact

If you have questions about any topic in this manual, contact your local authorised Mantis dealer.

### E. Special safety information

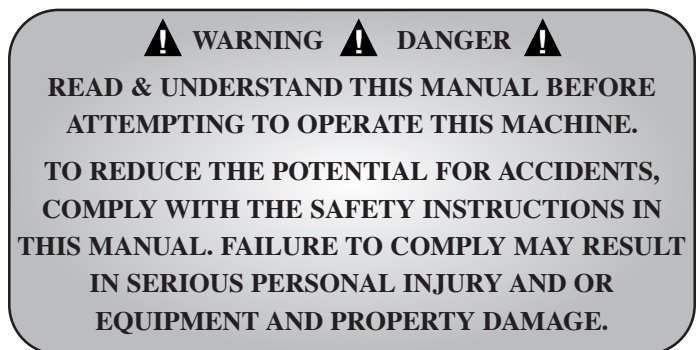

# Safety and warnings

## A. Safety labels

Please pay particular attention to the warning and information labels found on various parts of this line trimmer attachment unit. They are an important part of the safety system. These labels must be replaced in time due to abrasion, etc. It is your responsibility to replace the labels when they become hard to read. The location of these labels and their part numbers for ordering are shown below.

**⚠ WARNING - DANGER ⚠**

**IMPROPER USE OR CARE OF THIS LINE TRIMMER, OR FAILURE TO WEAR PROPER PROTECTION CAN RESULT IN SERIOUS INJURY.**

**READ AND UNDERSTAND THE RULES FOR SAFE OPERATION AND ALL INSTRUCTIONS IN THIS MANUAL.**

**WEAR EYE AND HEARING PROTECTION, AND PROPER CLOTHING.**

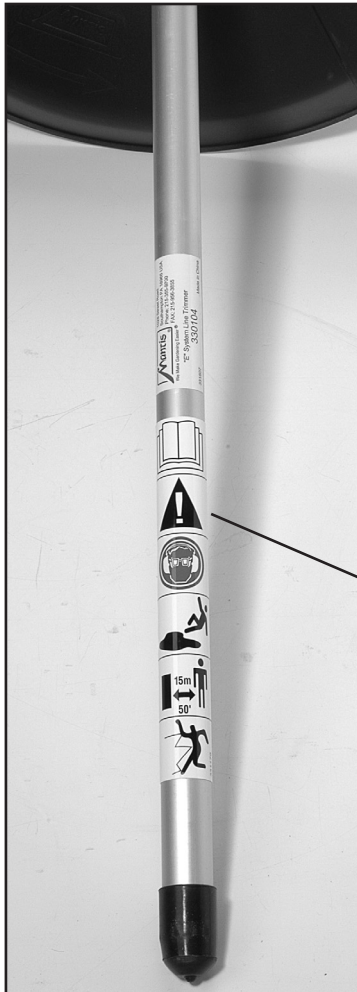

READ AND UNDERSTAND OPERATOR'S MANUAL BEFORE USING! KEEP IN SAFE PLACE!

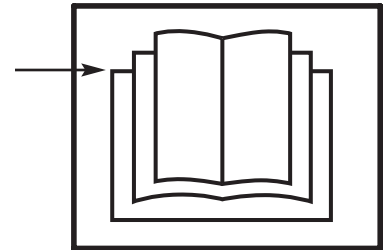

WARNING!

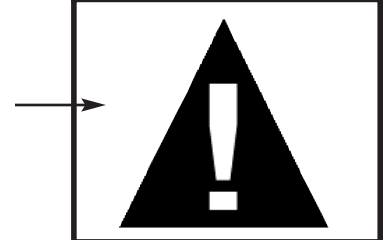

WEAR EYE AND EAR PROTECTION



WARNING! WEAR SLIP-RESISTANT FOOTWEAR. MAINTAIN FOOTING AND BALANCE AT ALL TIMES. DO NOT STAND ON SLIPPERY, UNEVEN OR UNSTABLE SURFACES. DO NOT WORK IN ODD POSITIONS OR ON LADDER. DO NOT OVER REACH.



KEEP BYSTANDERS AT A SAFE DISTANCE DANGER ZONE SURROUNDING THE OPERATOR. ONLY THE OPERATOR SHOULD BE IN THE DANGER ZONE!

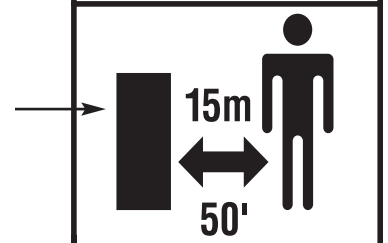

THROWN OBJECTS

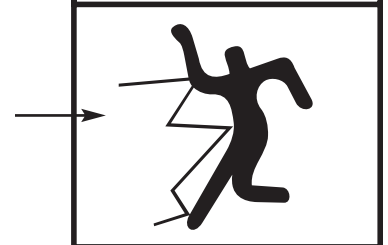

P/N 331179

## General safety rules

Never lean over the rotating cutting head. Rocks or other debris could be thrown into eyes and face and cause serious personal injury.



**WARNING**



**WHEN USING ELECTRIC TOOLS, BASIC SAFETY PRECAUTIONS, INCLUDING THE FOLLOWING, SHOULD ALWAYS BE FOLLOWED TO REDUCE THE RISK OF FIRE, ELECTRIC SHOCK AND PERSONAL INJURY.**

Pay particular attention to all sections regarding safety.

Read and understand all these instructions before operating this product and save these instructions. Be familiar with the controls and the proper use of equipment.

### For safe operations:

1. Keep work area clean.  
Cluttered areas and benches invite injuries.
2. Consider work area environment.  
Do not expose power tools to rain. Do not use power tools in damp or wet locations. Keep work area well lit. Do not use power tools where there is risk of fire or explosion.
3. Guard against electric shock.  
Avoid body contact with earthed or grounded surfaces, e.g. pipes, radiators, stoves, ovens, refrigerators.
4. Keep children away.  
Do not let visitors touch the tool or extension cord. All visitors should be kept away from area. Local regulations may restrict the age of the operator.
5. Store idle tools.  
When not in use, tools should be stored in a dry, high or locked up place, out of reach of children.
6. Do not force the tool.  
It will do the job better and safer at the rate for which it was intended. Walk, never run.
7. Use the right tool.  
Do not force small tools or attachments to do the job of a heavy duty tool. Do not use tools for purposes not intended; for example, do not use chain saw attachment to cut tree limbs or logs.
8. Dress properly.  
Do not wear loose clothing or jewellery that can be caught in moving parts. Long trousers, non-slip gloves and sturdy work shoes with non-skid soles are recommended when working outdoors. Wear protective hair covering to contain long hair.
9. Use protective equipment.  
To avoid injury, wear ear, eye protection, face or dust mask if the operation is dusty. To avoid injury from falling branches, wear helmet. Eye protection must meet applicable CE requirements.

10. Do not abuse the cord.  
Never carry the tool by the cord or yank it to disconnect it from the socket. Keep the cord away from heat, oil and sharp edges.
11. Maintain tool with care.  
Keep cutting tools sharp and clean for better and safer performance. Follow instructions for lubrication and changing accessories. Inspect tool cord periodically and if damaged, have it repaired by an authorised service facility. Inspect extension cords periodically and replace, if damaged. Keep handles dry, clean and free from oil and grease.
12. Disconnect tools.  
When not in use, before servicing and when changing accessories such as blades, bits and cutters.
13. Remove adjusting keys and spanners.  
Form the habit of checking to see that keys and adjusting spanners are removed from the tool before turning it on.
14. Avoid unintentional starting.  
Do not carry a plugged in tool with a finger on the switch trigger. Ensure switch is off when plugging in.
15. Use outdoor extension leads.  
When tool is used outdoors, use only extension cords intended for outdoor use.
16. Important extension cord information:
  - a. Make sure the extension cords are in good condition before use.
  - b. Based on the total length of cord that you are going to use, check the chart to make sure the cord meets the correct minimum cord gauge (AWG) requirements.

### IMPORTANT NOTE:

Using an undersized cord or a larger number cord gauge (AWG) than recommended in the chart, will cause a loss in power and overheating of the unit. Using a smaller number cord gauge (AWG) than recommended in the chart, is acceptable.

### Extension cord chart (minimum cord gauge (AWG))

Length (metres)	.3 to 7.8	7.9 to 15.5	15.6 to 30.6	30.7 to 45.7
Cord gauge (AWG)	18	16	14	12

17. Stay alert.  
Watch what you are doing. Use common sense. Do not operate tool when you are tired, ill or under the influence of alcohol or other drugs.

18. Check damaged parts.

Before further use of the tool, a guard or other part that is damaged should be carefully checked to determine that it will operate properly and perform its intended function. Check for alignment of moving parts, free running of moving parts, breakage of parts, mounting and any other conditions that may affect its operation. A guard or other part that is damaged should be properly repaired or replaced by an authorised service centre unless otherwise indicated in this instruction manual. Have defective switches replaced by an authorised service facility. Do not use the tool if the switch does not turn it on and off.

**Don't** operate the machine with a damaged or excessively worn cutting device.

**⚠ WARNING – DANGER ⚠**

**LITTLE WONDER WILL NOT BE RESPONSIBLE FOR THE FAILURE OF CUTTING DEVICES OR ACCESSORIES THAT HAVE NOT BEEN TESTED AND APPROVED FOR USE WITH THIS UNIT. USE ONLY MANUFACTURER-RECOMMENDED REPLACEMENT PARTS.**

19. The use of any accessory or attachment, other than those recommended in this instruction manual, may present a risk of personal injury.

20. Have your tool repaired by a qualified person.

This electric tool conforms to relevant safety requirements. Repairs should only be carried out by qualified persons using original spare parts, otherwise this may result in considerable danger to the user.

21. Keep in mind that the operator or user is responsible for accidents or hazards occurring to other people or their property.

22. Work only in daylight or in good artificial light.

23. Keep all guards attached at all times when unit is operated.

24. Always use the shoulder strap.

Adjust the strap for comfort before starting the engine.

25. Secure unit during transport to prevent damage or injury.

26. **Machine should not be used in any position that causes any part to come within 3 metres of overhead electrical lines.** Always be aware of overhead power lines.

27. **Always** keep a firm grip on both handles when motor is running: one hand grasps the front “loop” handle while the other hand grasps the rear handle. Severe injuries can result if you try to use this machine with only one hand or with an insecure grip.

28. **Thoroughly** inspect the area where equipment is to be used and removed all objects, which can be thrown by the machine.

29. **Always** keep area clear of children, pets, and bystanders.

30. **Always** inspect your unit before each use and ensure that all handles, guards and fasteners are secure, operating, and in place. Be sure that all electrical cords are not damaged or broken.

31. **Always** maintain and examine your attachments with care. Follow maintenance instructions given in manual.

32. **Don't** attempt to repair any part of the extended reach E System. Have repairs made by a qualified repairman. See that only original “Mantis” parts are used.

33. Maintain a firm footing and good balance, do not overreach while trimming. Before you start to trim, check the work area for obstacles that might cause you to lose your footing, balance or control of the machine. While operating the machine always be sure of a safe and secure operating position and be sure of your footing on slopes.

**⚠ WARNING – DANGER ⚠**

**IMPROPER ASSEMBLY OF THIS EQUIPMENT CAN RESULT IN SERIOUS INJURY. MAKE SURE TO FOLLOW ALL INSTRUCTIONS CAREFULLY. IF YOU HAVE ANY QUESTIONS, CONTACT YOUR LOCAL AUTHORISED MANTIS DEALER.**

34. Always disconnect power cord from power source:

- Before cleaning blockages.
- Before checking, cleaning or working on the cutting portion of the unit.
- After striking a foreign object: inspect the cutting part for damage and make repairs before restarting and operating the unit.
- If machine starts to vibrate abnormally (check immediately).
- Whenever you leave the unit.

35. Securing the extension cord.

Bend the extension cord about 40 cm from the plug end. Push that bend through the oblong opening, then loop the bend under the cord retaining clips as shown. This will prevent the extension cord from detaching from the line trimmer plug.





## Assembling the line trimmer

1. Locate and open sealed bag with 3 screws, 3 split washers, clamp plate #2 and L-pin. (Picture 1)
2. Remove plastic tube and gear case cover #4 from the threaded shaft.
3. Place plastic guard over the gear case flange, and place clamp plate #2 over the plastic guard. Align holes and attach it with three screws to the trimmer attachment assembly. (Picture 3)
4. Place gear case cover #4 onto the gear shaft. (Picture 4)
5. Lock the gear shaft by inserting the supplied pin through the slot in the plastic guard and into the aligned openings in the gear case cover and gear case (Picture 5). Screw in the spool holder with the spool to the gear shaft by turning it counter clockwise (Picture 6). Hand tighten it securely and remove pin. (Picture 7)



Picture 1

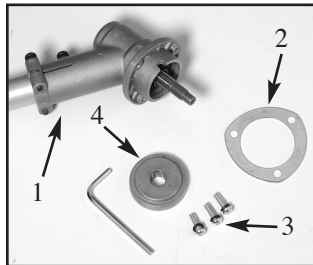

Picture 2

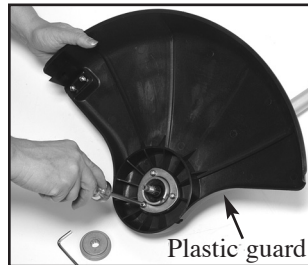

Picture 3

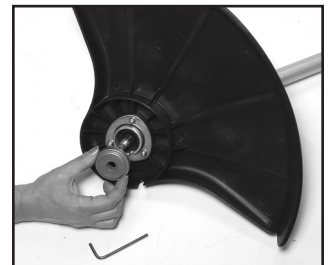

Picture 4

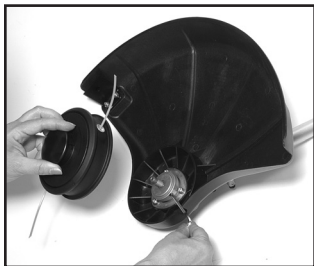

Picture 5



Picture 6



Picture 7

## Attaching the Line Trimmer to the Power Head

*No tools are required to attach the Line Trimmer to the power head assembly.*

1. Pull the spring pin up on the adapter of the power head shaft assembly. (Picture 8)
2. Carefully fit the line trimmer drive shaft into the adapter, making sure that the male spline of the inner drive shaft engages into the female spline socket of the power head shaft. (Picture 9)
3. When the drive shaft is properly aligned, the spring pin will drop into the hole on the shaft of the line trimmer attachment. (Picture 10) A click should be heard when completed.
4. Insure two shaft parts are fully engaged by twisting them. Full engagement will prevent shaft rotation.
5. Secure assembly by tightening the knob. (Picture 11)
6. Unit handles can be re-adjusted to the operator's preference by simply loosening the screws and sliding the handles up or down the shaft.

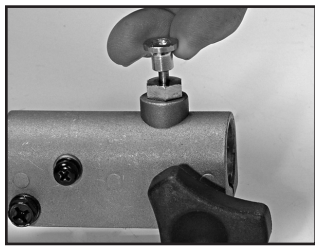

Picture 8

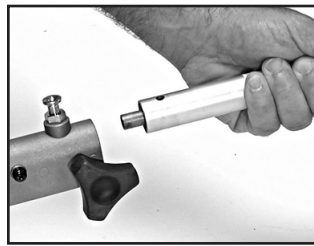

Picture 9



Picture 10



Picture 11

## Balancing the unit

Check the balance of the assembled unit. The handles and shoulder harness have been assembled at the factory and set according to the average size person. This can be adjusted to the operator's preference by simply loosening the screws and sliding handles up or down the shaft. Re-tighten the screws.

## Trimming techniques

1. With both hands on the handles, push lockout trigger button with your thumb first, and then squeeze trigger. **Start cutting when spool rotates at full RPM.**

Picture 12

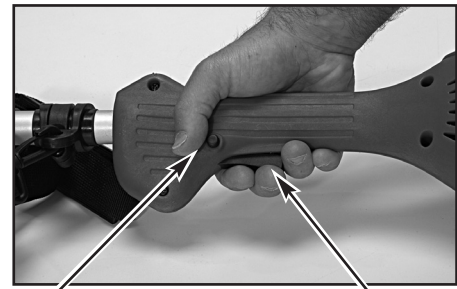

Lockout Trigger Button

Trigger

2. Always remember that the tip of the line does the cutting. You will not get better results by moving line deeply into the cutting area.
3. Hold the cutting head of the unit off the ground, and use a sweeping (left to right) motion. Try to control cutting motion with the hip rather than placing the full workload on the arm and hands.
4. The rate of the cutting motion depends on the material being cut: heavy growth will require slower action.
5. Take precautions to avoid wire or dry long-stem plant material from wrapping around the cutting head shaft. This can stall the head. If repeated frequently, this can cause damage of the unit.

## Adjusting the length of the line

Operator can increase the length of the line when it becomes short, without stopping the engine. In order to do this you have to lightly tap the head of the string trimmer on the bear ground or hard soil while running the engine at full throttle.

## Storage

1. Clean.
2. Lubricate for rust prevention
3. Store indoors.

## Refilling the trimming line

**⚠ WARNING ⚠ DANGER ⚠**  
**NEVER REPLACE OR ADJUST THE TRIMMING LINE WHILE MOTOR IS RUNNING!**  
**DISCONNECT POWER CORD FROM THE POWER SOURCE.**

Replacement spools can be ordered through your Mantis dealer.

1. For safety reasons, **do not use metal reinforced line.**
2. For replacement use 0.095 inch (2.5 mm) diameter line. The spool is capable to hold approximately 6 m long line.
3. Hold spool holder and remove spool by turning it clockwise until it stops. **Do not press the spool down when turning!** Pull the spool and remove old line.
4. Put each end of the new line through the holes in the spool and pull it until one end is approx. 15 cm longer than the other. (Pictures 13 and 14)
5. Hold the spool, so the opening is facing you, and wind up the line tightly and evenly turning the spool in the clockwise direction, separating both line halves by finger as shown below. (Pictures 15 and 16)
6. Insert line into the slots in the spool, and leave approx 15 - 20 cm in of line unwind, then put the ends through the eyelets on the spool holder. (Pictures 17 and 18)
7. Align bosses of the drive with the grooves in the spool, and push it in place.
8. Pull both lines until they come free from the slots in the spool.
9. Hold drum and turn spool counter clockwise until it stops. **Do not press the spool down when turning!** (Picture 19)

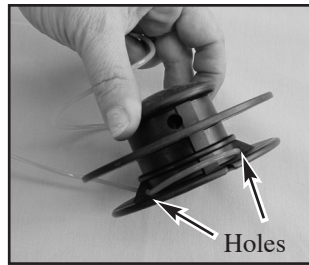

Picture 13

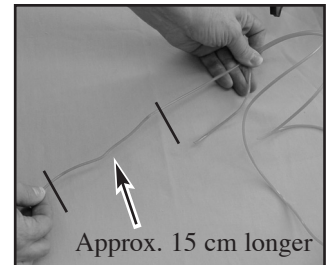

Picture 14



Picture 15



Picture 16

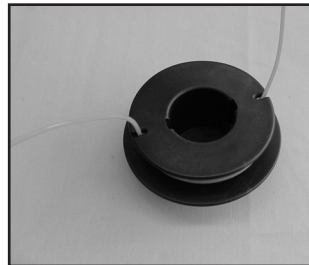

Picture 17

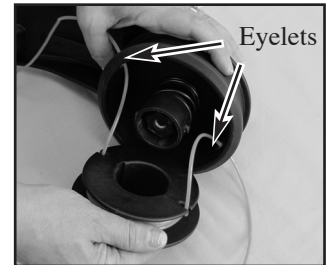



Picture 18



Picture 19

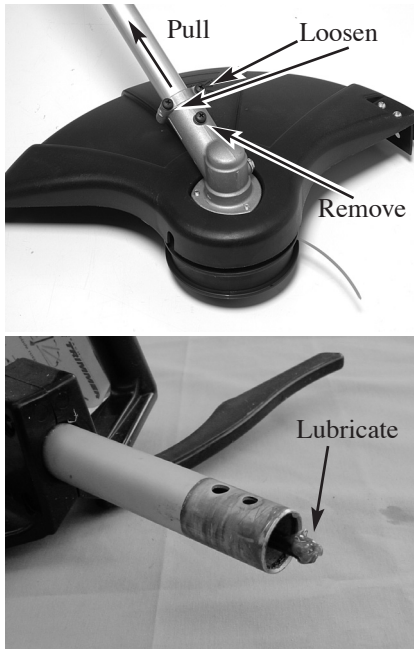

# Maintenance

Area	Maintenance procedure	Frequency
<p>Spline male/female connection of the inner drive shaft</p> 	<p>Inspect/lubricate</p> <ol style="list-style-type: none"> <li>1. Remove centre screw, and loosen up other two as shown on the diagram (left).</li> <li>2. Pull the shaft from the gear housing.</li> <li>3. Pull and clean internal shaft.</li> <li>4. Lubricate.</li> <li>5. Re-install the drive shaft.</li> </ol>	<p>20-25 hrs</p>
<p>Gear case</p> 	<p>Inspect/clean debris</p> <p>Remove plug and check level of grease. Add grease. Do not overfill! Use EP2 lithium grease</p>	<p>45-50 hrs</p>
<p>Screws/nuts/bolts</p>	<p>Inspect/tighten/replace</p>	<p>Before each use</p>

Area	Maintenance	Before Use	Every 25 hours	Every 50 hours	Every 100 hours	Note
Cutting parts	Replace if something is wrong	✓				
Screws, nuts bolts	Tighten, replace	✓			✓	Not adjusting screws

**IMPORTANT:** Time intervals shown are maximum. Actual use and your experience will determine the frequency of required maintenance.

# Line Trimmer E System Exploded View

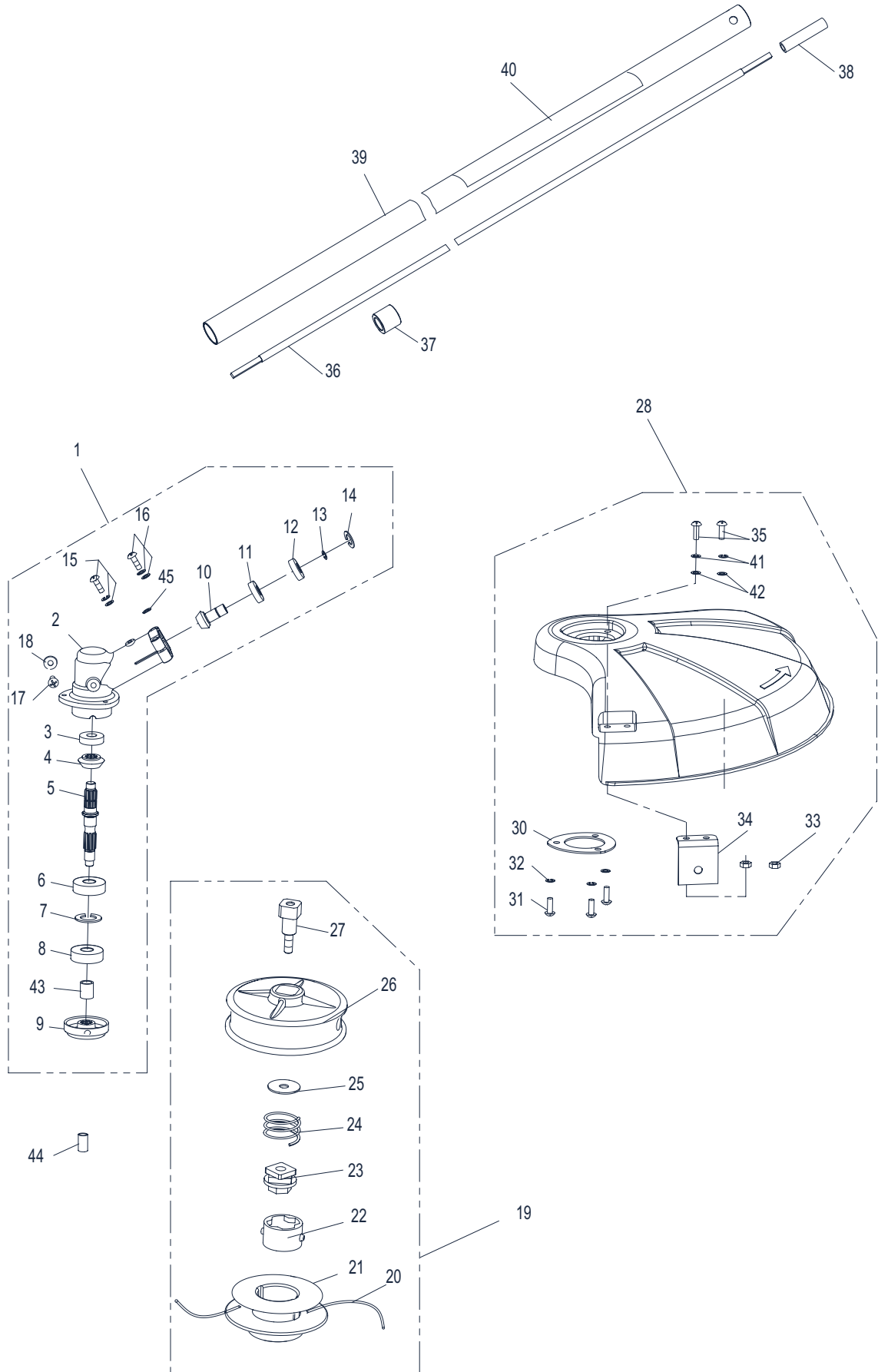

## Line Trimmer E System Parts List

KEY #	DESCRIPTION	PART #	QTY	KEY #	DESCRIPTION	PART #	QTY
1	GEAR CASE-ASS'Y	331186	1	23	RATCHET	331203	1
2	GEAR CASE	331187	1	24	SPRING	331204	1
3	BEARING 609	331146	1	25	PLATE	331205	1
4	GEAR	331188	1	26	SPOOL HOLDER	331206	1
5	MAIN GEAR HOUSING SHAFT	331189	1	27	CENTRE INSERT	331207	1
6	BEARING 6201	331190	1	28	GUARD ASS'Y		
7	SNAP RING	331191	1		WITH CLAMPING PLATE	331306	1
8	SEAL	331192	1	30	CLAMPING PLATE	331210	1
9	GEAR CASE COVER	331193	1	31	SCREW M5X16	331528	3
10	PINION	331194	1	32	LOCK WASHER	331529	3
11	BEARING 61900	331195	1	33	NUT M5	331530	2
12	BEARING 61900Z	331196	1	34	CUTTING BLADE	331211	1
13	SNAP RING	331197	1	35	SCREW M5X16	331531	2
14	SNAP RING	331198	1	36	INTERNAL SHAFT 628X7MM	331212	1
15	SCREW W/WASHERS M5X12	331560	1	37	SPACER	331213	1
16	SCREW W/WASHERS M5X30	331525	2	38	INTERNAL SHAFT ADAPTER	331214	1
17	SCREW M8X12	331526	1	39	OUTER SHAFT 024X623MM	331215	1
18	WASHER	331527	1	40	WARNING LABEL	331179	1
19	CUTTING HEAD 4 INCH	331199	1	41	LOCK WASHER	331532	2
20	TRIMMER LINE	331200	1	42	FLAT WASHER	331533	2
21	SPOOL	331201	1	43	BUSHING	331294	1
22	SPOOL LOCKING PART	331202	1	44	PROTECTIVE SLEEVE	331295	1

**2 YEAR LIMITED SERVICE & WARRANTY POLICY  
FOR LINE TRIMMER ATTACHMENT**

MANTIS extends this limited warranty against defects in material and workmanship for a period of two years from the date of purchase, to the first retail purchaser and each subsequent owner during the warranty period. This warranty covers all portions of the Mantis E System Line Trimmer.

MANTIS will repair or replace, at its option, any part or parts of the product proven to be defective in material or workmanship under normal usage during the warranty period. Warranty repairs and replacements will be made without charge for parts or labor. All parts replaced under warranty will be considered as part of the original product, and any warranty on the replaced parts will expire coincident with the original product warranty. In the event of a defect or malfunction, the purchaser must send the product, postage paid to:

Mantis  
2800 Turnpike Dr.  
Suite #1  
2800 Commerce Center  
Hatboro, PA 19040

MANTIS assumes no responsibility in the event that the product was assembled or used in noncompliance with any assembly, care, safety, or operating instructions contained in the Owner's Manual; was not used with reasonable care; or was misused, used for other than normal or intended purposes. This warranty does not extend to parts affected or damaged by normal wear and tear.

MANTIS MAKES NO EXPRESS OR IMPLIED WARRANTIES OR REPRESENTATIONS EXCEPT THOSE CONTAINED HEREIN. THE DURATION OF ANY IMPLIED WARRANTY, INCLUDING MERCHANTABILITY AND FITNESS FOR A PARTICULAR PURPOSE, IS LIMITED TO THE DURATION OF THIS WRITTEN LIMITED WARRANTY. MANTIS DISCLAIMS ALL LIABILITY FOR INDIRECT AND/OR CONSEQUENTIAL DAMAGES. SOME STATES DO NOT ALLOW LIMITATIONS ON HOW LONG AN IMPLIED WARRANTY LASTS AND/OR DO NOT ALLOW THE EXCLUSION OR LIMITATION OF INCIDENTAL OR CONSEQUENTIAL DAMAGES, SO THAT ABOVE LIMITATIONS AND EXCLUSIONS MAY NOT APPLY TO YOU. THIS WARRANTY GIVES YOU SPECIFIC LEGAL RIGHTS, AND YOU MAY ALSO HAVE OTHER RIGHTS WHICH VARY FROM STATE TO STATE.

**MANTIS**  
**1028 Street Road**  
**Southampton , PA 18966**  
**(215) 355-9700**



**MANTIS**  
**1028 Street Road**  
**Southampton , PA 18966**  
**+ (215) 355-9700**